

Axiom Installation Guide

SD1 - Alpha

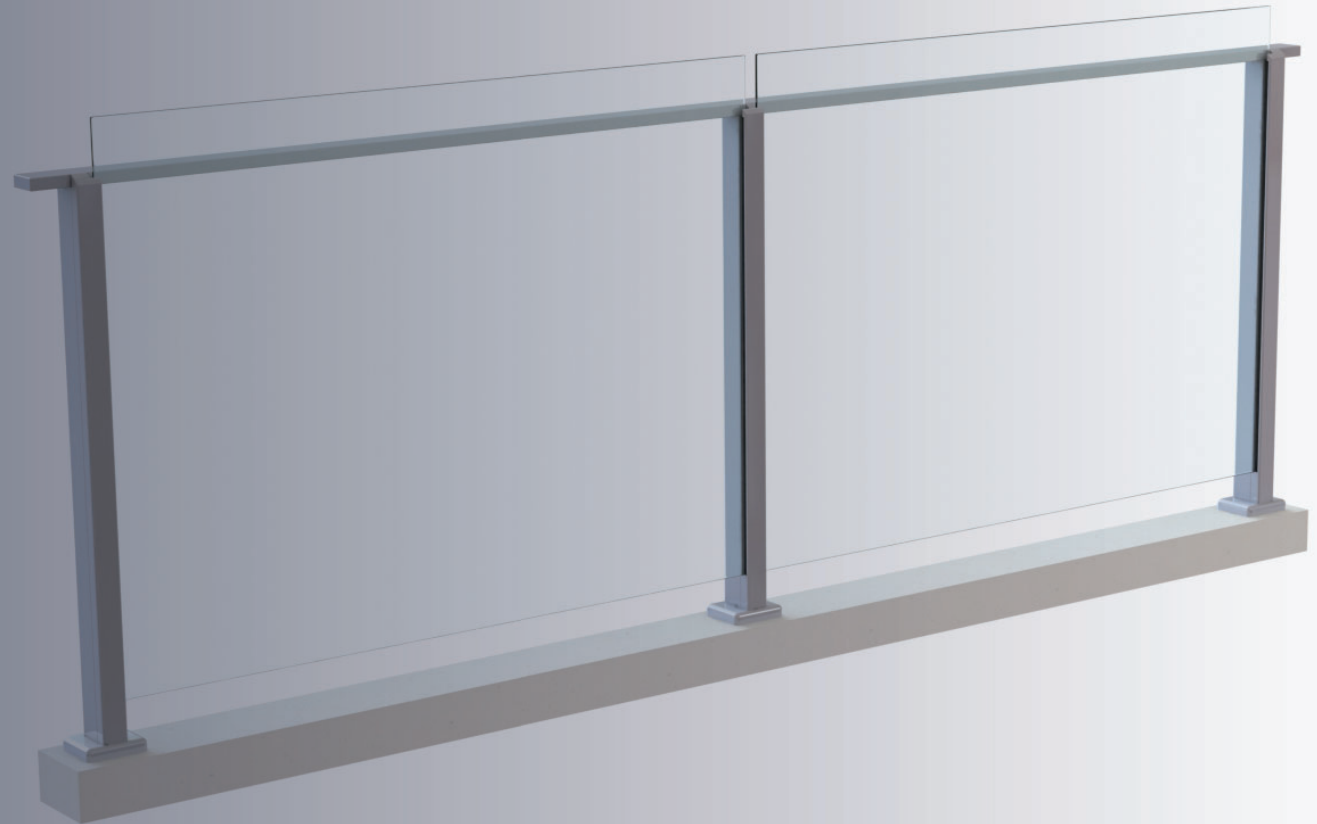

**Surrounded
by Experts.**

TM

Index

Disclaimer_____ 3
SD1-01 & SD1-02 Assembly_____ 4
SD1-01 & SD1-02 Baseplate Connection___ 5
SD1-03 & SD1-04 Assembly_____ 6
SD1-03 & SD1-04 Baseplate Connection___ 7
SD1-05 & SD1-06 Assembly_____ 8
SD1-05 & SD1-06 Baseplate Connection___ 9
SD1-07 Assembly_____ 10
SD1-07 Baseplate Connection_____ 11
SD1-08 & SD1-09 Assembly_____ 12
SD1-08 & SD1-09 Baseplate Connection___ 13
SD1-10 & SD1-11 Assembly_____ 14
SD1-10 & SD1-11 Baseplate Connection___ 15
Innerrail connection_____ 16
Glazing, Rubber and Gaskets_____ 17

Disclaimer and Important Notes

- (a) Except as provided in the Terms, all express and implied warranties, guarantees and conditions under statute or general law as to:
 - (i) merchantability, description, quality, suitability or fitness of the Goods or Services for any purpose; or
 - (ii) design, assembly, installation, materials, workmanship or otherwise,are expressly excluded.
- (b) Axiom is not liable for physical or financial injury, loss or damage or consequential loss or damage of any kind arising out of:
 - (i) the supply, layout, assembly, installation or operation of the Goods or Services; or
 - (ii) Axiom's negligence or other act or omission.
- (c) In addition to, and without in any way limiting, paragraphs (a) and (b) above, and notwithstanding that Axiom may provide engineering drawings, which (if it does) must be read in conjunction with Axiom's installation instructions:
 - (i) it is the Customer's responsibility to comply with all Australian laws, all Standards (including but not limited to AS1288 and AS1170.1), the Building Code and the requirements of all relevant authorities;
 - (ii) the Customer must ensure that any existing structures or substrates to which the Goods are being affixed to are verified by a project engineer as structurally suitable to safely support the Goods or any other items being affixed to the structures or substrates; and
 - (iii) the Customer must fully insert and tighten all fasteners (including but not limited to baseplate screws) before installation of the Goods.

Alpha (SD1-01 & SD1-02) Assembly

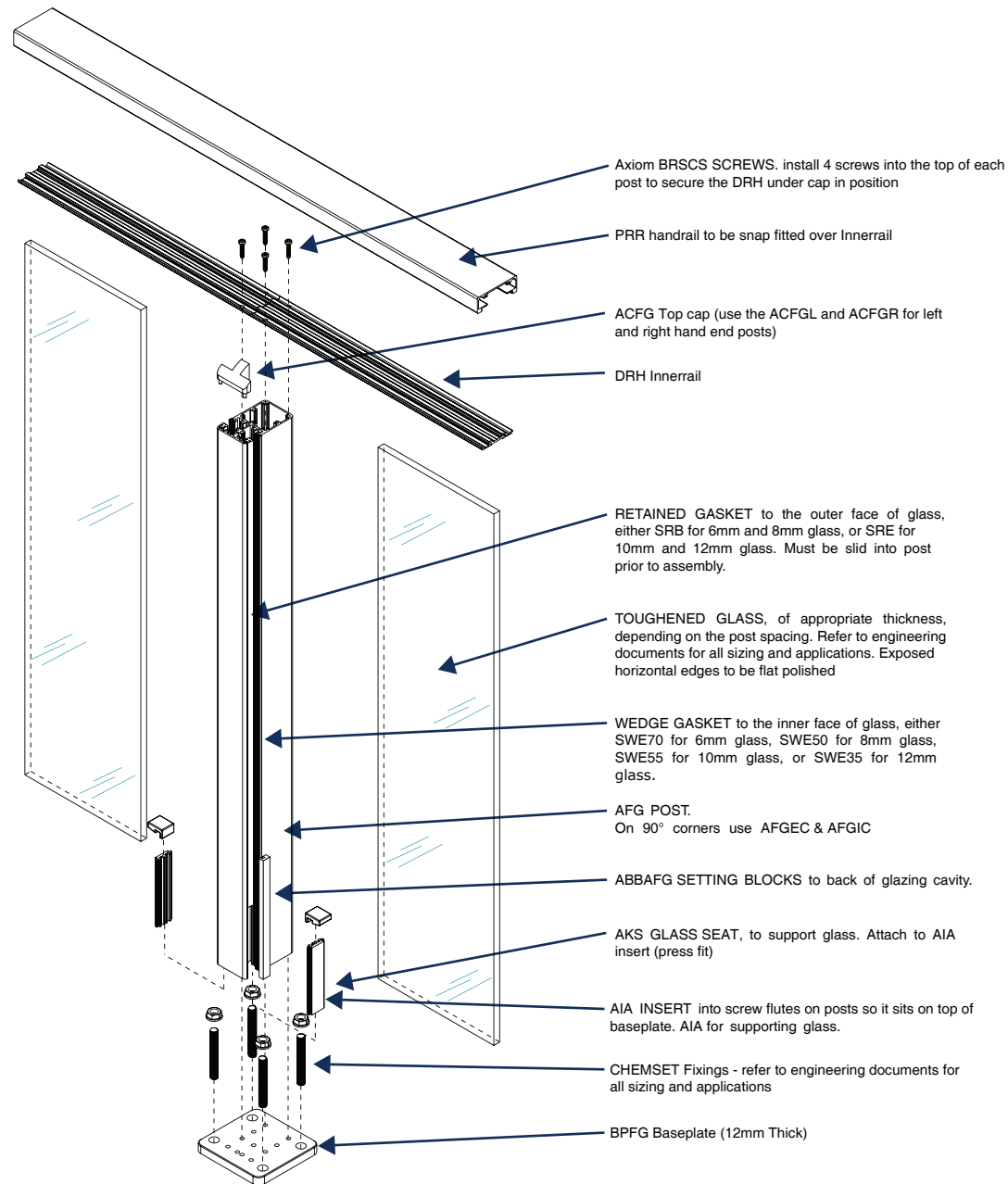

Alpha (SD1-01 & SD1-02) Baseplate connection

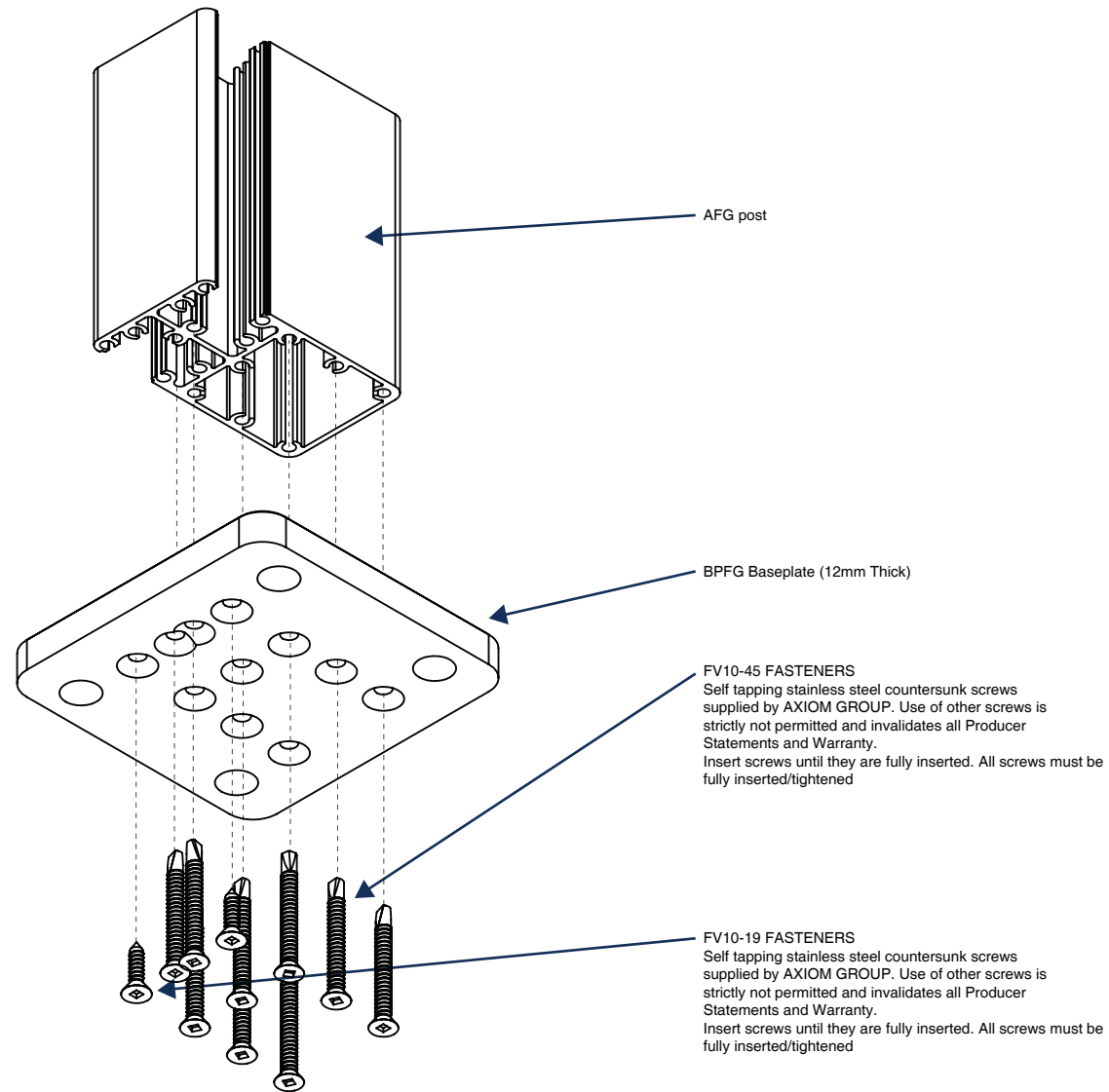

Alpha (SD1-03 & SD1-04) Assembly

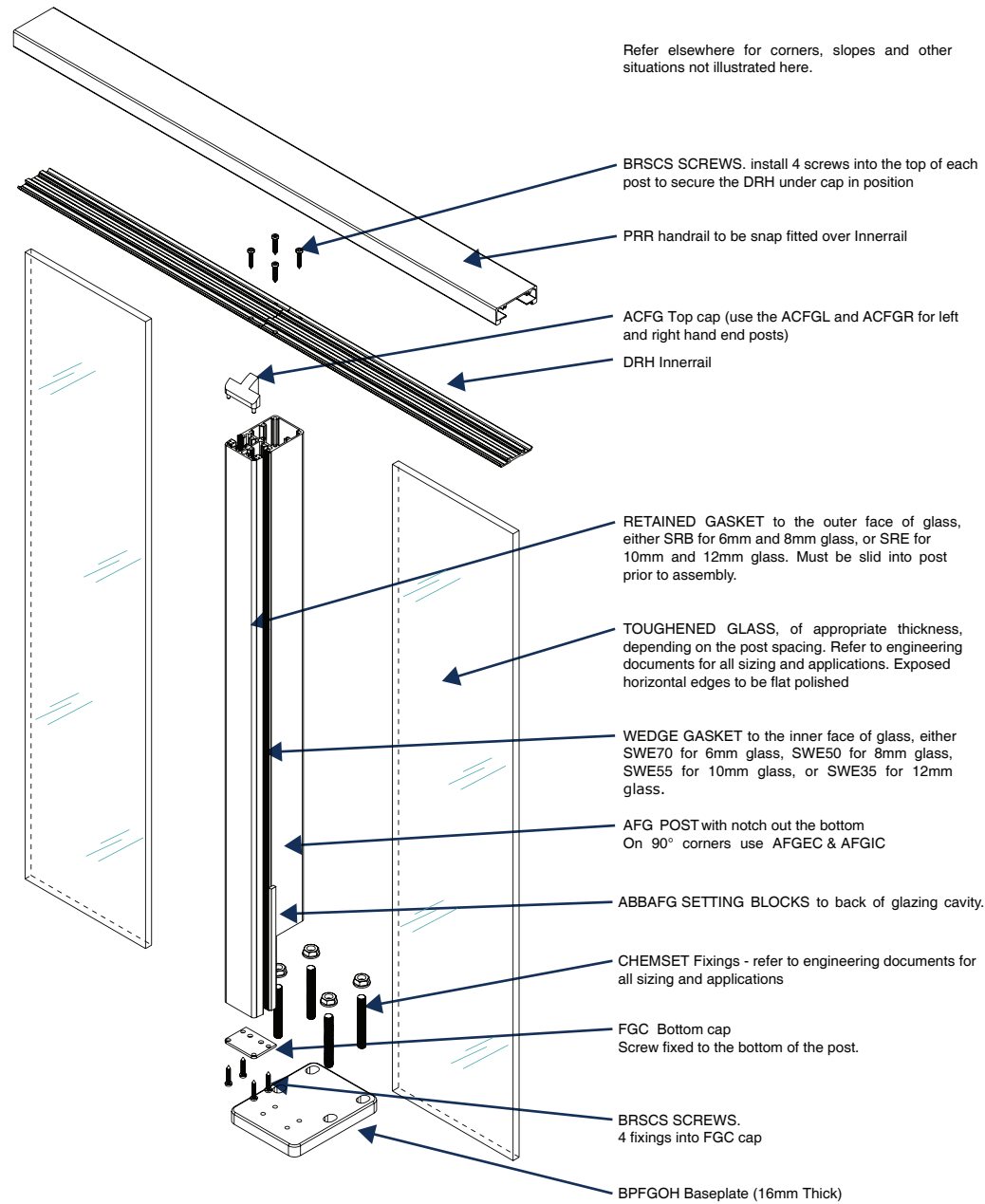

Alpha (SD1-03 & SD1-04) Baseplate connection

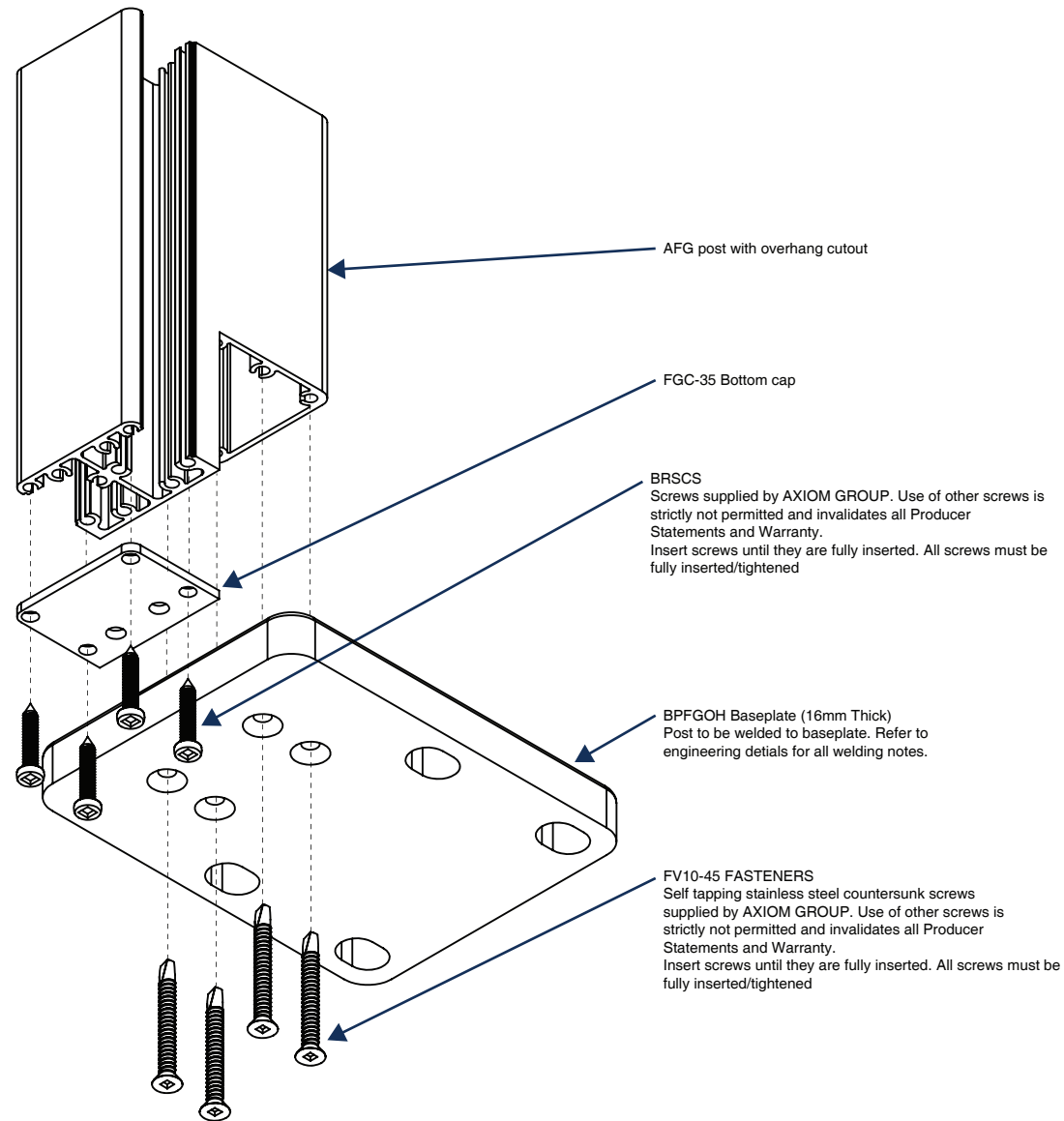

Alpha (SD1-05 & SD1-06) Assembly

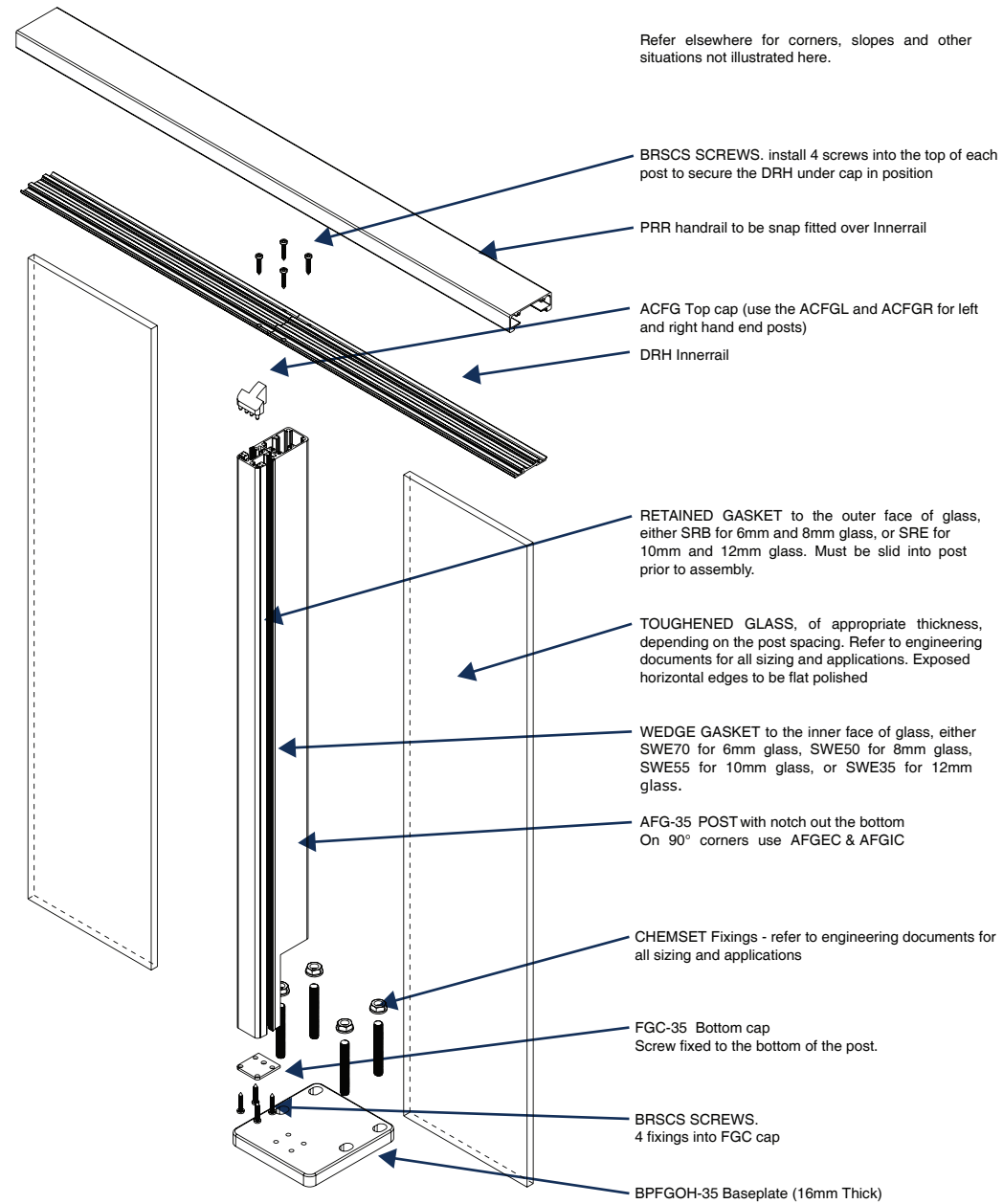

Alpha (SD1-05 & SD1-06) Baseplate connection

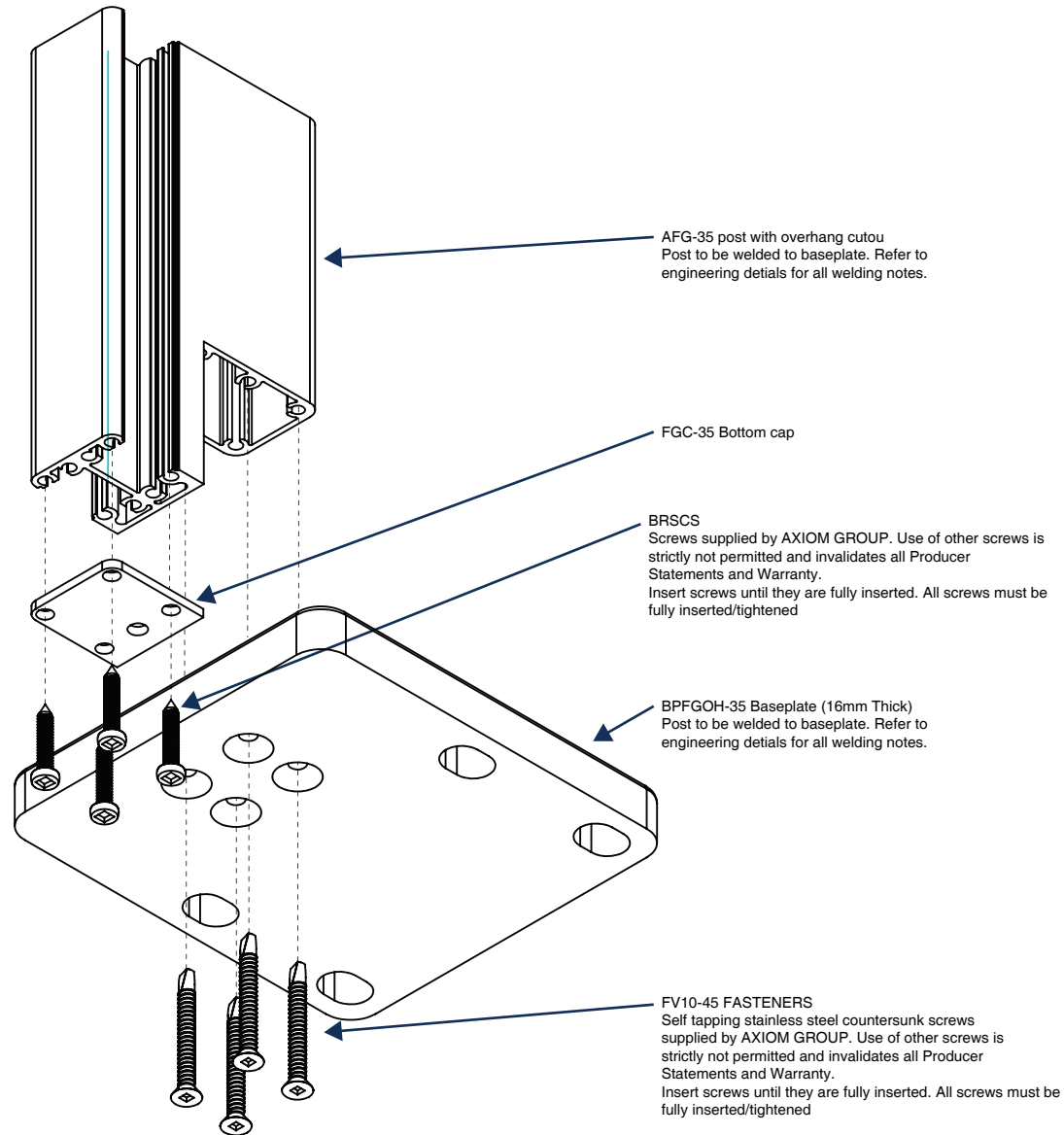

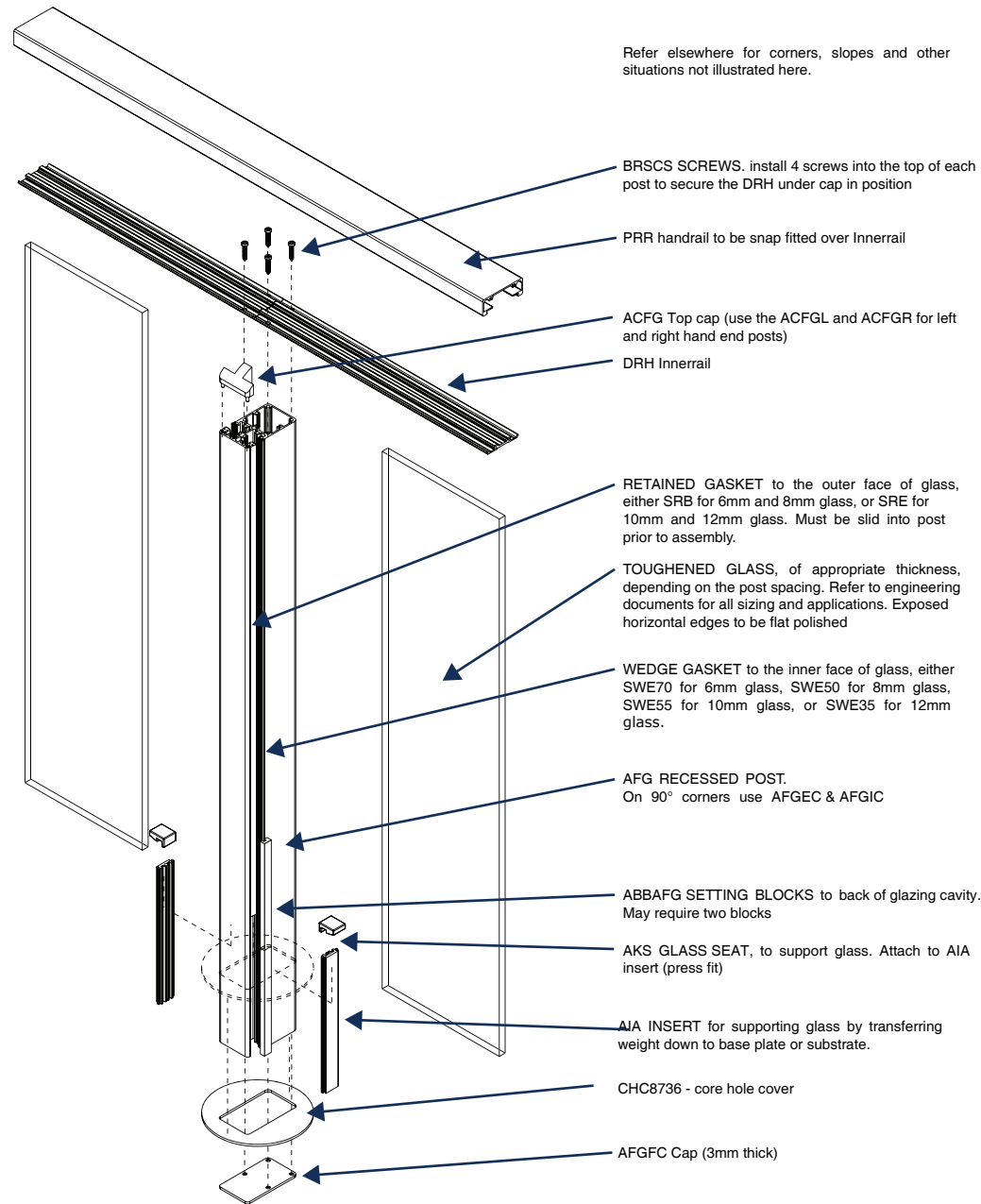

Alpha (SD1-07) Baseplate connection

Only refer to this page if you are installing the balustrade design on Axiom suite drawing

SD1-07

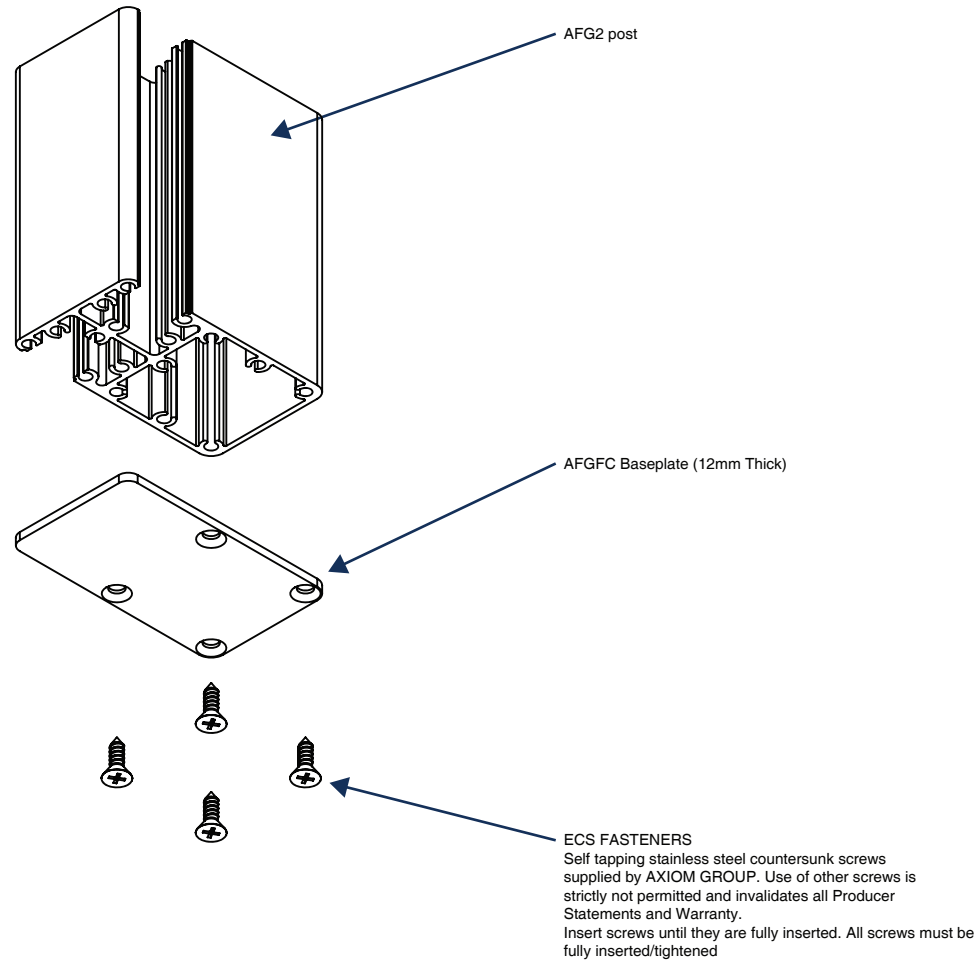

Alpha (SD1-08 & SD1-09) Assembly

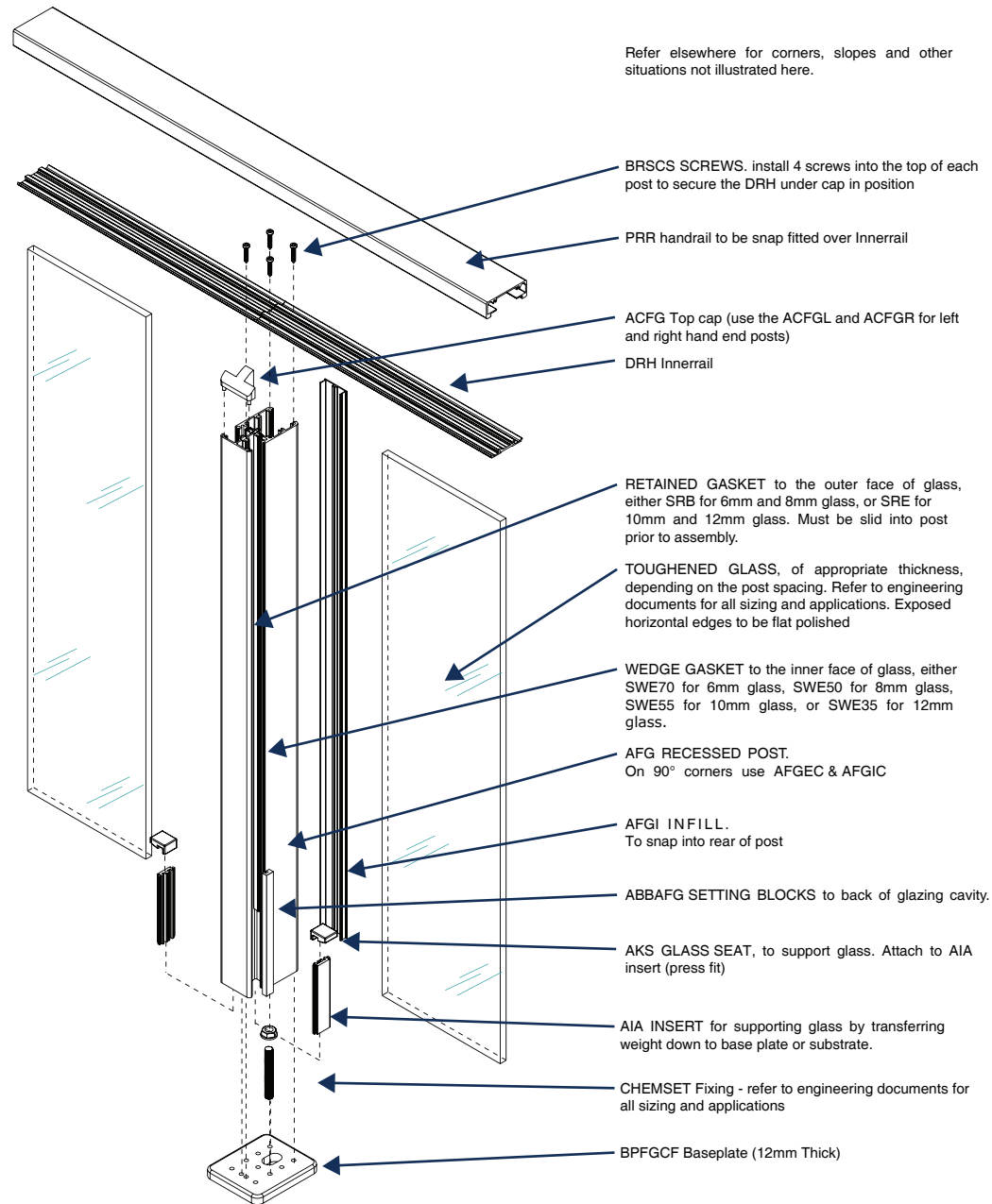

Alpha (SD1-08 & SD1-09) Baseplate connection

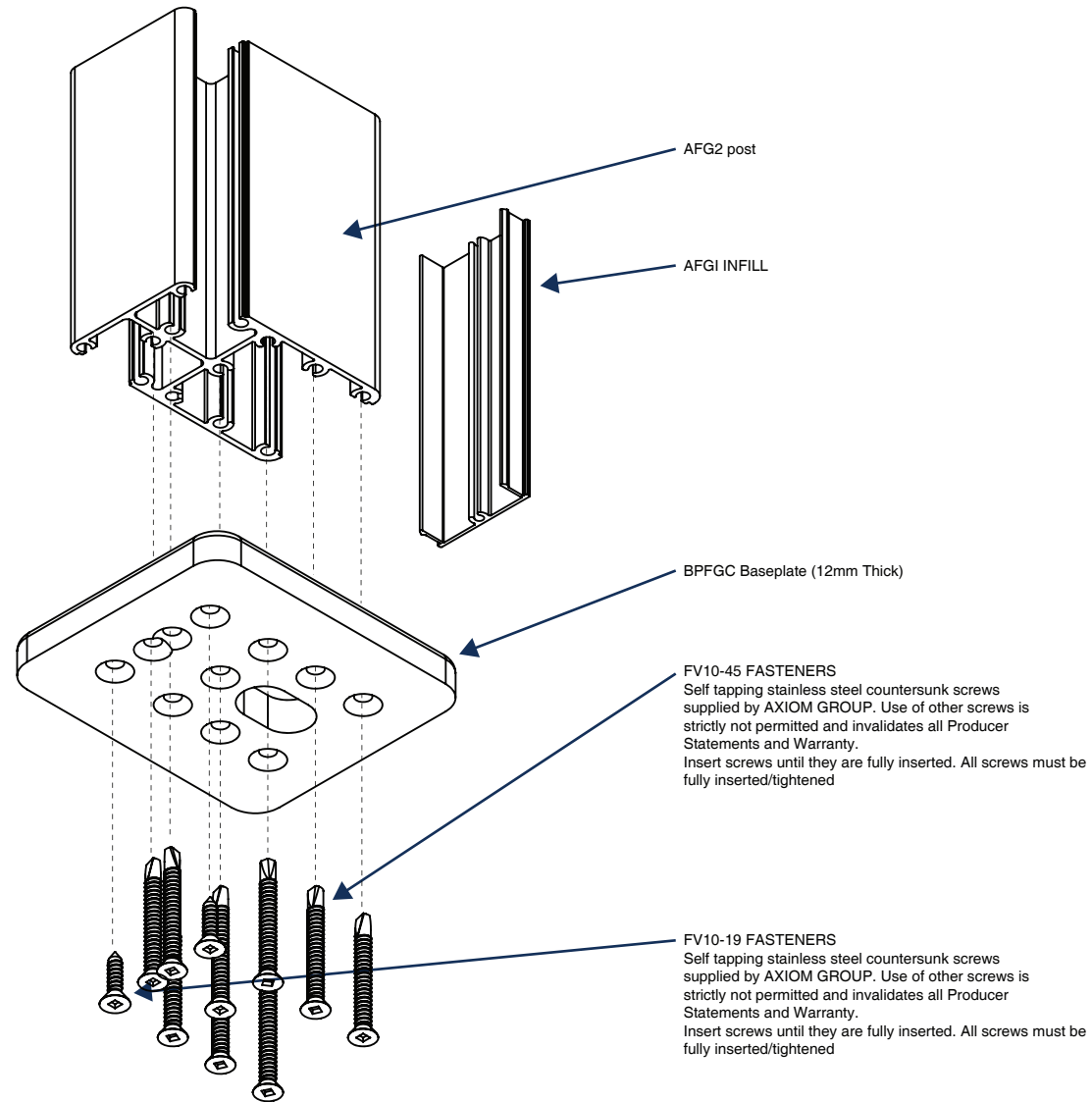

Alpha (SD1-10 & SD1-11) Assembly

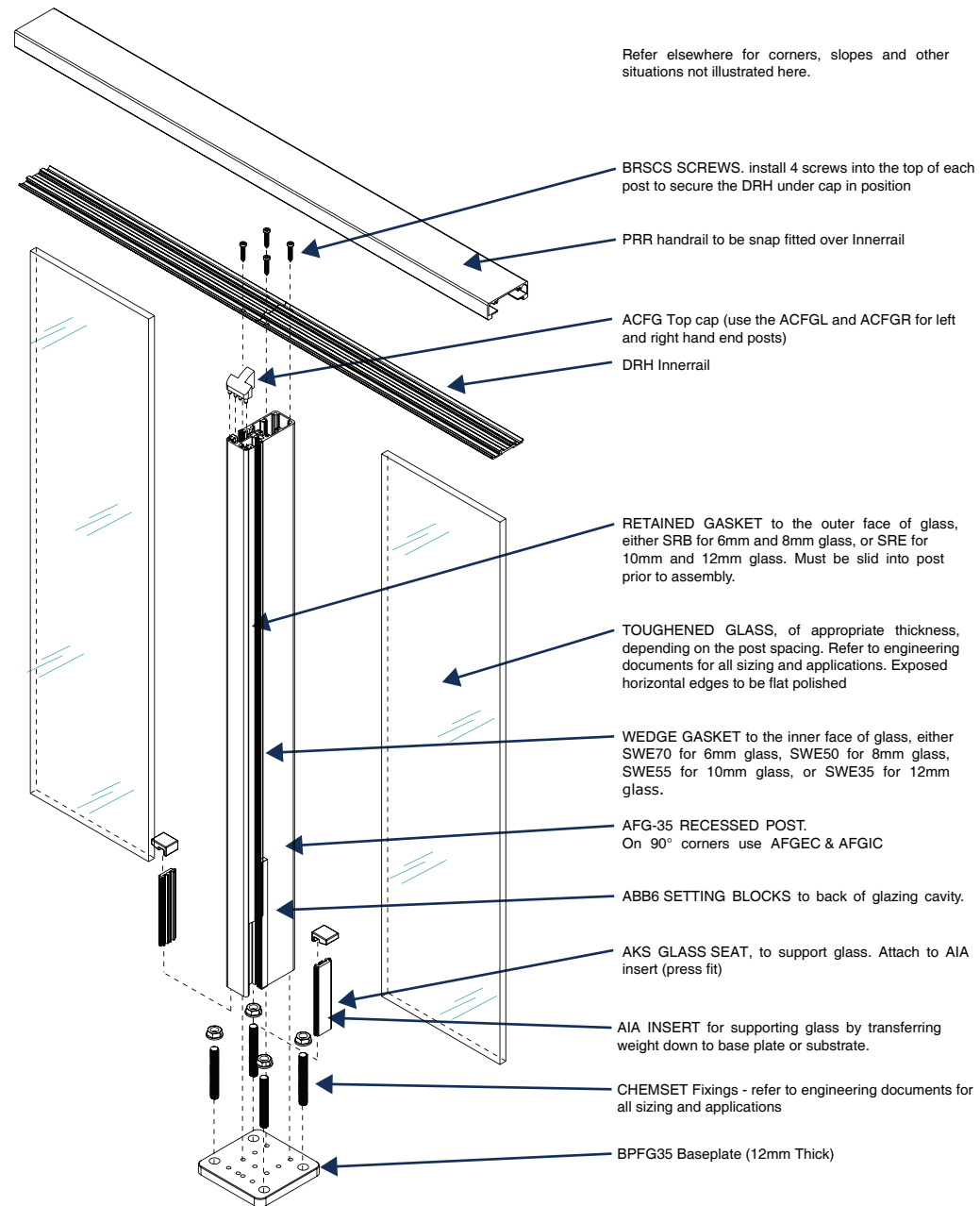

Alpha (SD1-10 & SD1-11) Baseplate connection

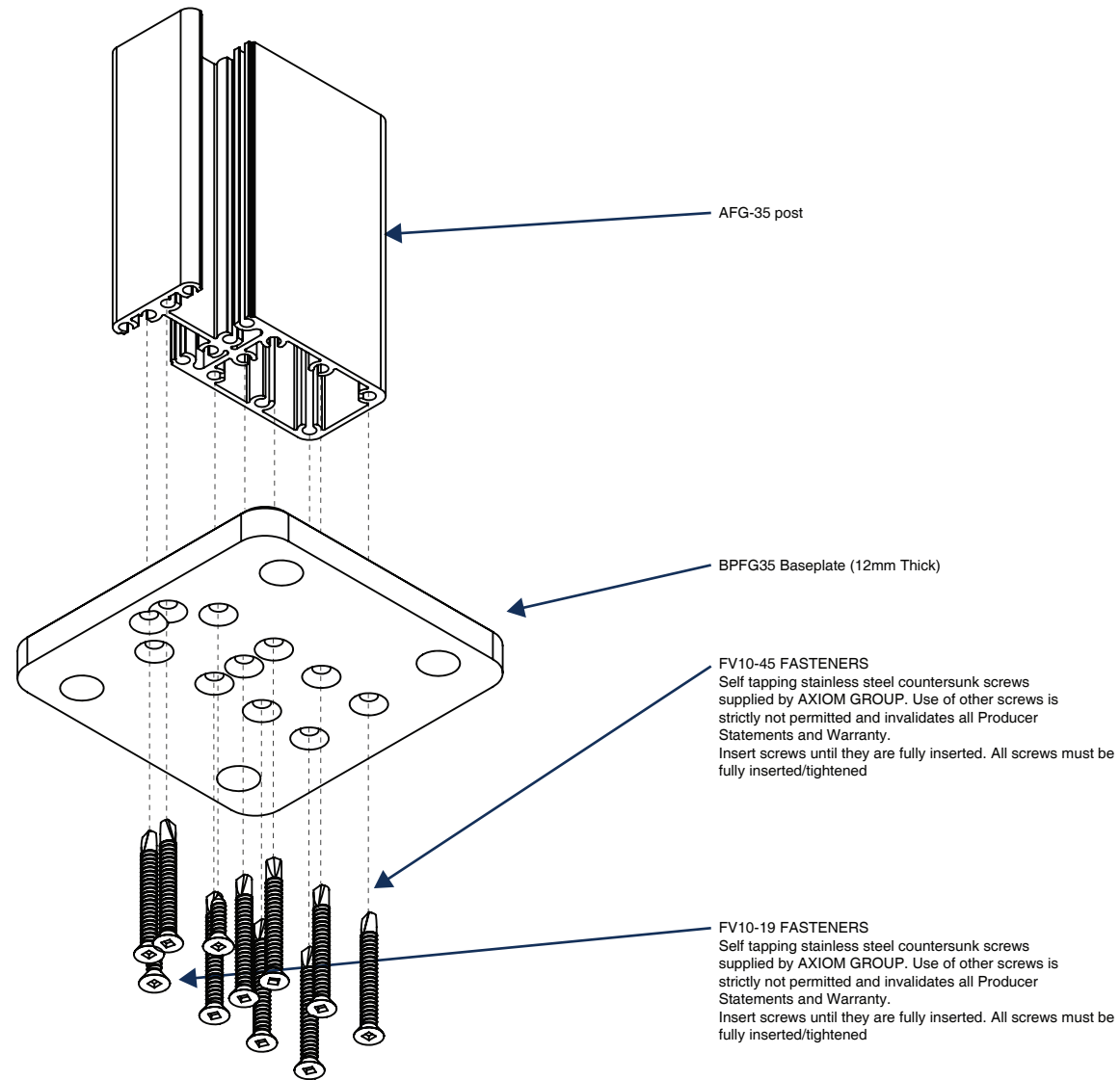

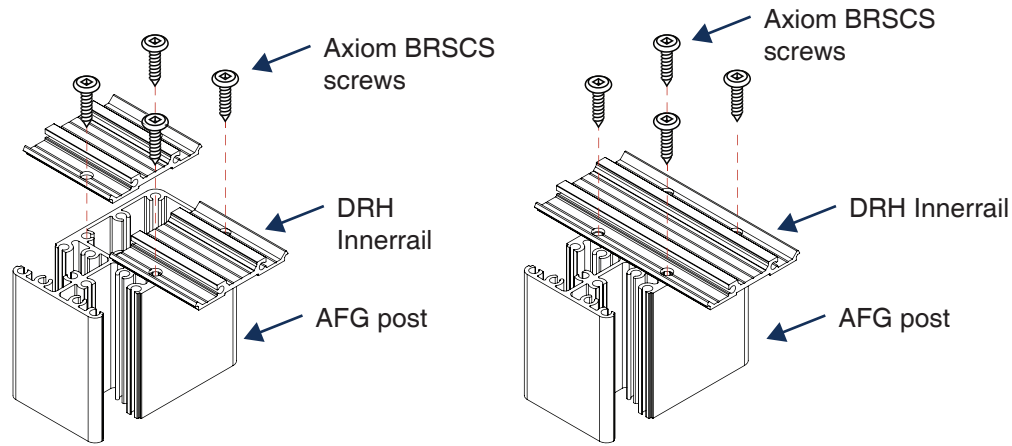

FIG. 1

FIG. 1

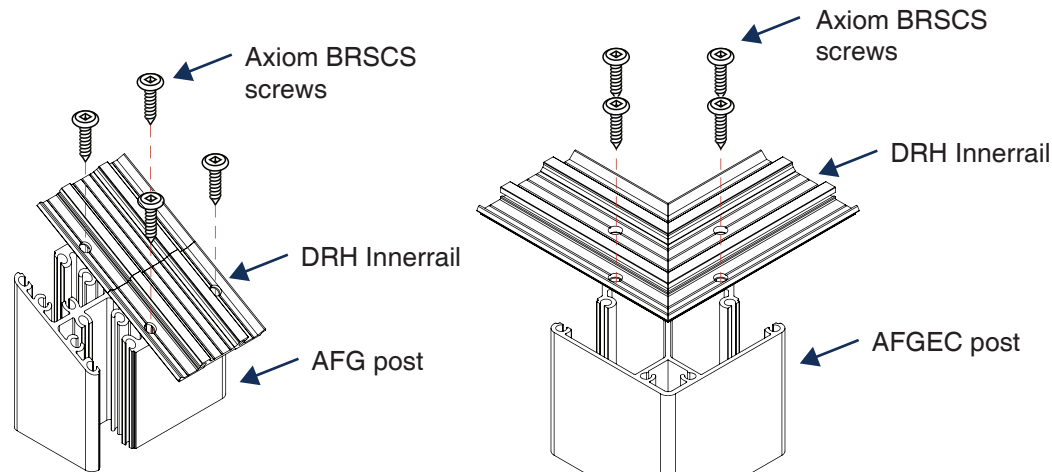

FIG. 3

FIG. 2(A)

FIG 1. CONNECTION TO IN-LINE POSTS

BRSCS screws required, 4 per post. 5.5mm Ø fixing holes to be drilled on the outer groove lines of the Inner Rail. See Fig 1 which illustrates use with both continuous and non continuous Inner Rails.

FIG 2. CONNECTION CORNER POSTS

The Inner Rail is mitred over the post, to the desired angle. BRSCS screws required, 2 per rail end. 5.5mm Ø fixing holes to be drilled on the Inner Rail centreline. Fig 2 shows a typical arrangement.

FIG 3. CONNECTION OF SLOPING RAILS TO POST

BRSCS screws required, 4 per posts on the outer groove lines of the Inner Rail. Drill 5.5mm Ø fixing holes at the correct angle to the rail. Fig 3 shows a typical arrangement.

Insert screws until they are fully inserted. All screws must be fully inserted/tightened

GLAZING

This section covers the measuring and installation of the glass panes. Ensure the correct thickness of toughened glass is used.

INSTALL GLASS

Glass is to be installed by shuffle glazing. Fit Setting block within the post to ensure glass is blocked in accordance with AS1288 and can not dislodge

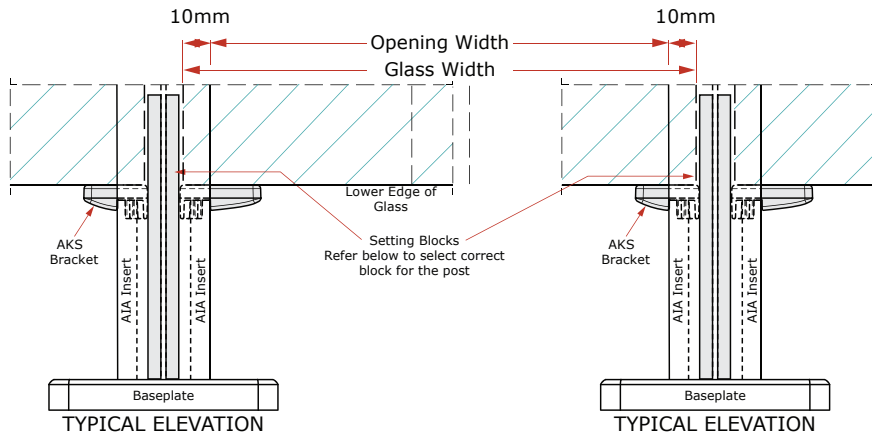

RETAINED GLAZING GASKET

Install the correct retained glazing gasket. Refer table below.

Glazing Gasket Guide		
Glass Thickness	External Rubber	Internal Rubber
6mm	SRB	SWE70
10mm	SRE	SWE55
12mm	SRE	SWE35



ABB20 - AFGEC
(Glazing block orientation 2)



ABB20 - AFGEC
(Glazing block orientation 2)

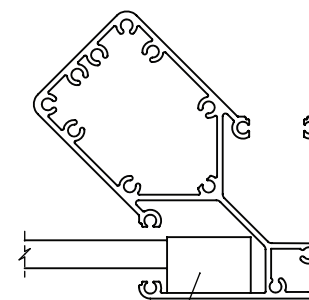

ABB6 - AFGEC

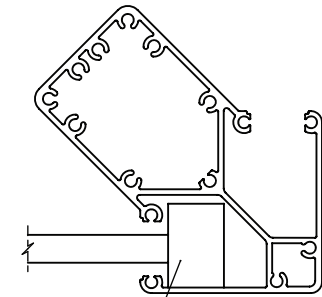

ABBAFG - AFG

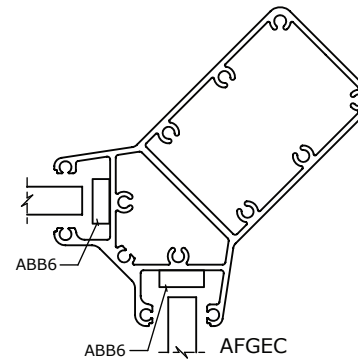
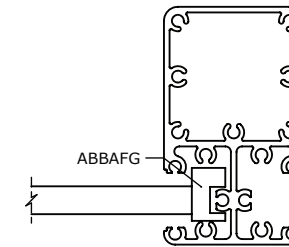
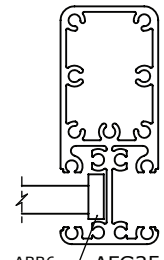

ABB6 - AFG35